

Model EC80 - External Single Halyard

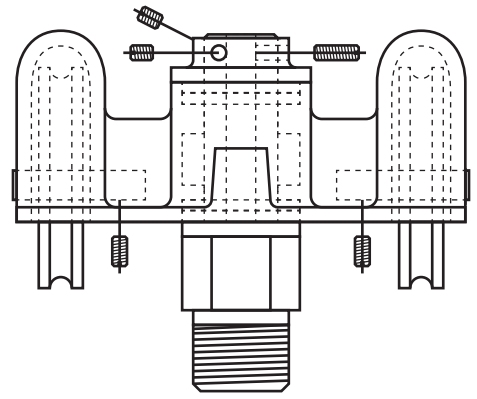
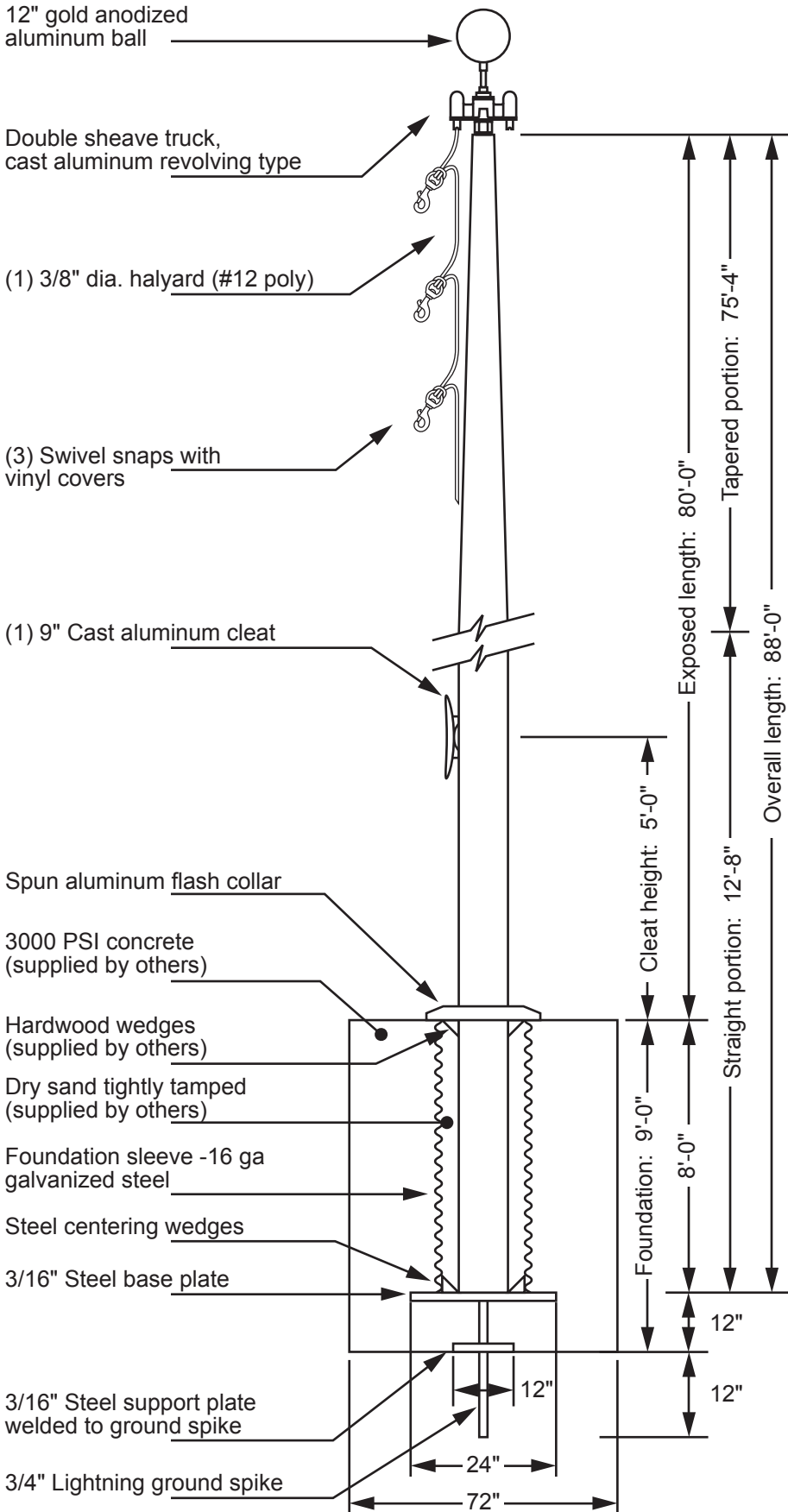

Double Sheave Truck Detail
 Revolving truck
 Cast aluminum body
 Stainless steel ball bearings
 Cast aluminum sheaves
 Cast aluminum spindle

All shafts with overall length of more than 38'-6" are shipped in multiple sections.

Each section is matched and marked for field assembly. Exposed portion of jam sleeve must be **well lubricated** prior to assembly.

1-1/2" maximum gap allowed for field fitting.

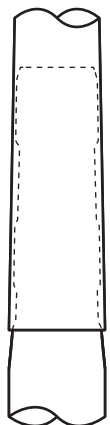

Project:
 Location:
 Contractor:
 Customer:

Date:
 Job:
 Revision:

Exposed Height __ 80'-0"
 Overall Height __ 88'-0"
 Butt Diameter __ 12"
 Top Diameter __ 4"
 Wall Thickness __ .375"
 Ships in 3 sections

Ground Set Tapered Aluminum Flagpole
 ALLOY 6063T6
 80 grit polish
 FINISH:

EDER FLAG
 1000 W. Rawson Avenue
 Oak Creek, WI 53154
 www.ederflag.com

