

Model ECX30 - External Single Halyard

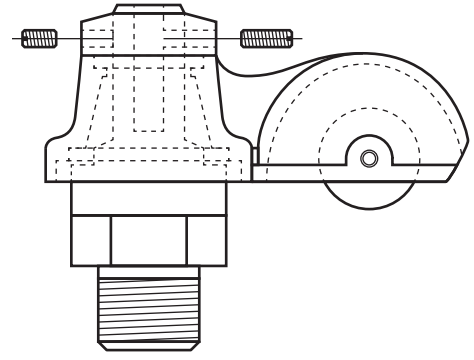
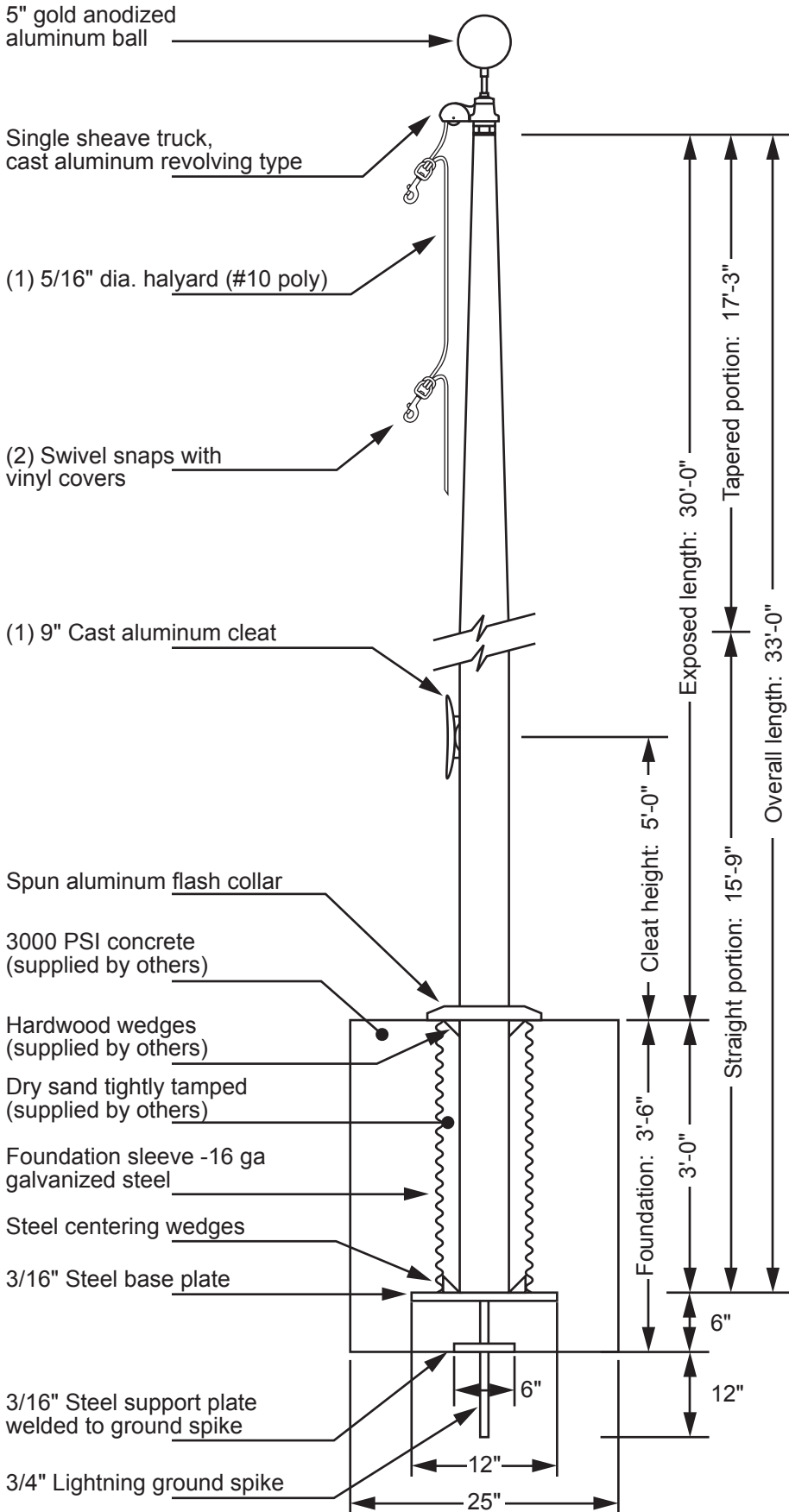

Single Sheave Truck Detail
 Revolving truck
 Cast aluminum body
 Stainless steel ball bearings
 Nylon sheave
 Cast aluminum spindle

Project:
 Location:
 Contractor:
 Customer:

Date:
 Job:
 Revision:

Exposed Height __ 30'-0"
 Overall Height __ 33'-0"
 Butt Diameter __ 5"
 Top Diameter __ 3"
 Wall Thickness __ .125"
 Ships in 1 section

Ground Set Tapered
 Aluminum Flagpole
 ALLOY 6063T6
 80 grit polish

FINISH:

EDER FLAG
 1000 W. Rawson Avenue
 Oak Creek, WI 53154
 www.ederflag.com

