

Model ECH35 - Hurricane External Single Halyard

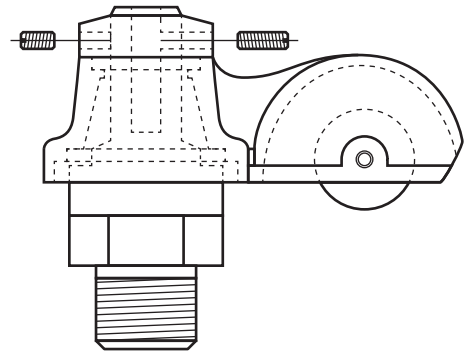
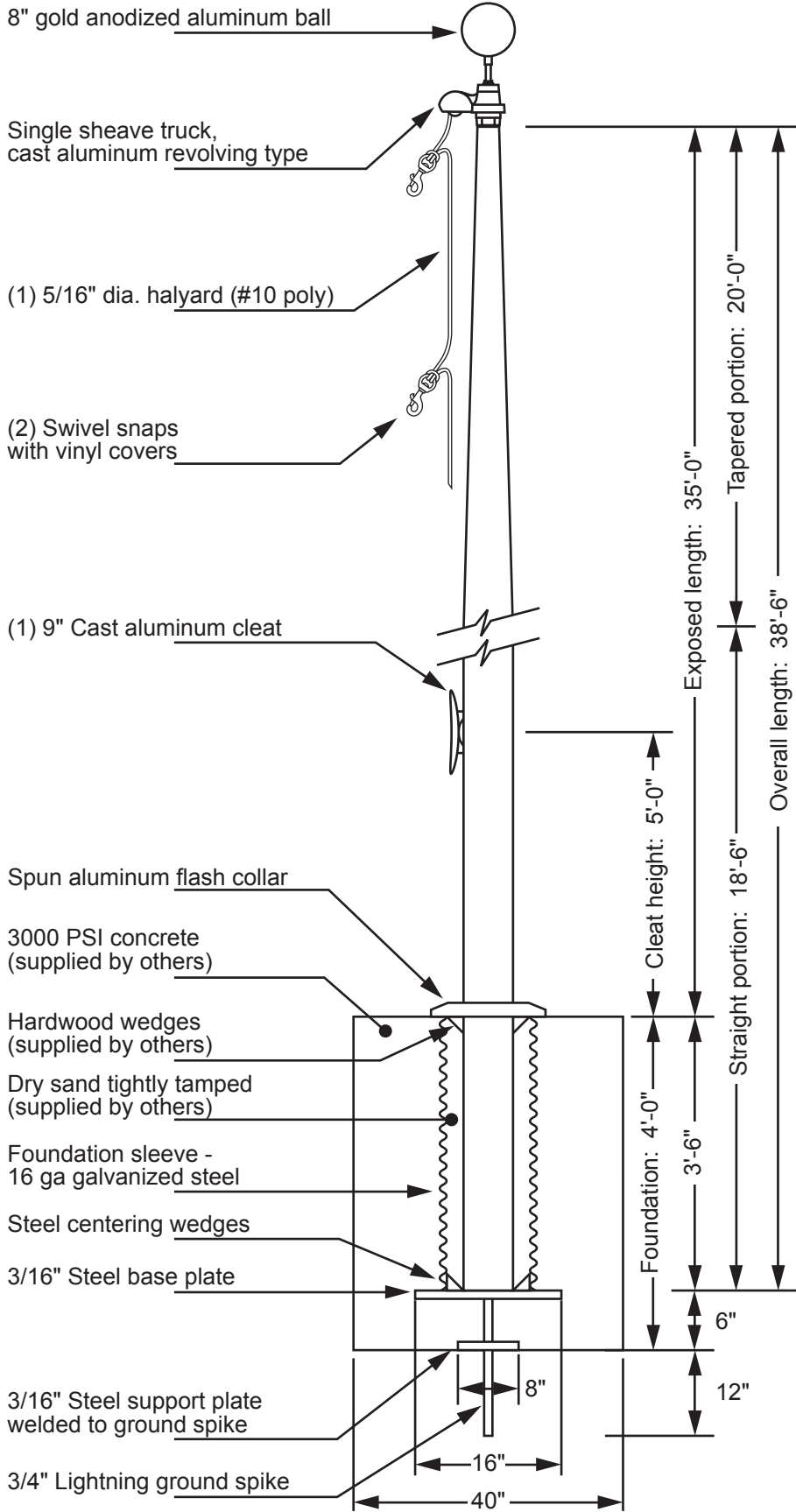

Single Sheave Truck Detail

- Revolving truck
- Cast aluminum body
- Stainless steel ball bearings
- Nylon Sheave
- Cast aluminum spindle

All shafts with overall length of more than 38'-6" are shipped in multiple sections.

Each section matched and marked for field assembly. Exposed portion of jam sleeve must be **well lubricated** prior to assembly.

1-1/2" maximum shop gap allowed for field fitting.

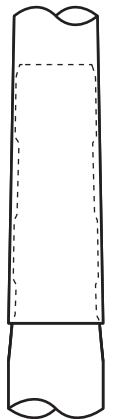

Project:
Location:
Contractor:
Customer:

Date:
Job:
Revision:

Exposed Height __ 35'-0"
Overall Height __ 38'-6"
Butt Diameter __ 8"
Top Diameter __ 3-1/2"
Wall Thickness __ .250"
Ships in 2 section

Ground Set Tapered Aluminum Flagpole ALLOY 6063T6 80 grit polish
FINISH:

EDER FLAG
1000 W. Rawson Avenue
Oak Creek, WI 53154
www.ederflag.com

