

Model ECH40 IH - Hurricane Internal Halyard

Single sheave truck, cast aluminum revolving, internal halyard truck

1/8" x 7 x 19 Mil-C-5424
Stainless steel aircraft cable

Standard flag arrangement: 8' x 12'

Neoprene coated 2" x 7" diameter
steel counterweight

Nylon beaded retainer ring

Gearless, self locking direct drive
winch with six tumbler cylinder lock

Spun aluminum flash collar

3000 PSI concrete
(supplied by others)

Hardwood wedges
(supplied by others)

Dry sand tightly tamped
(supplied by others)

Foundation sleeve -
16 ga galvanized steel

Steel centering wedges

3/16" Steel base plate

3/16" Steel support plate
welded to grounding spike

3/4" Lightning ground spike

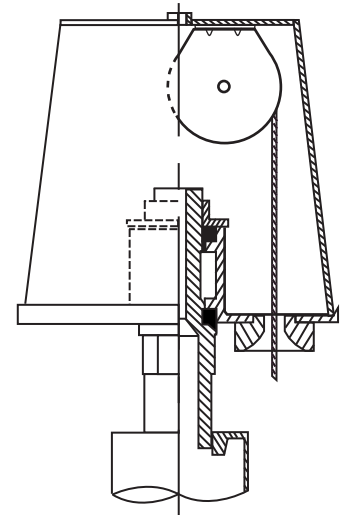
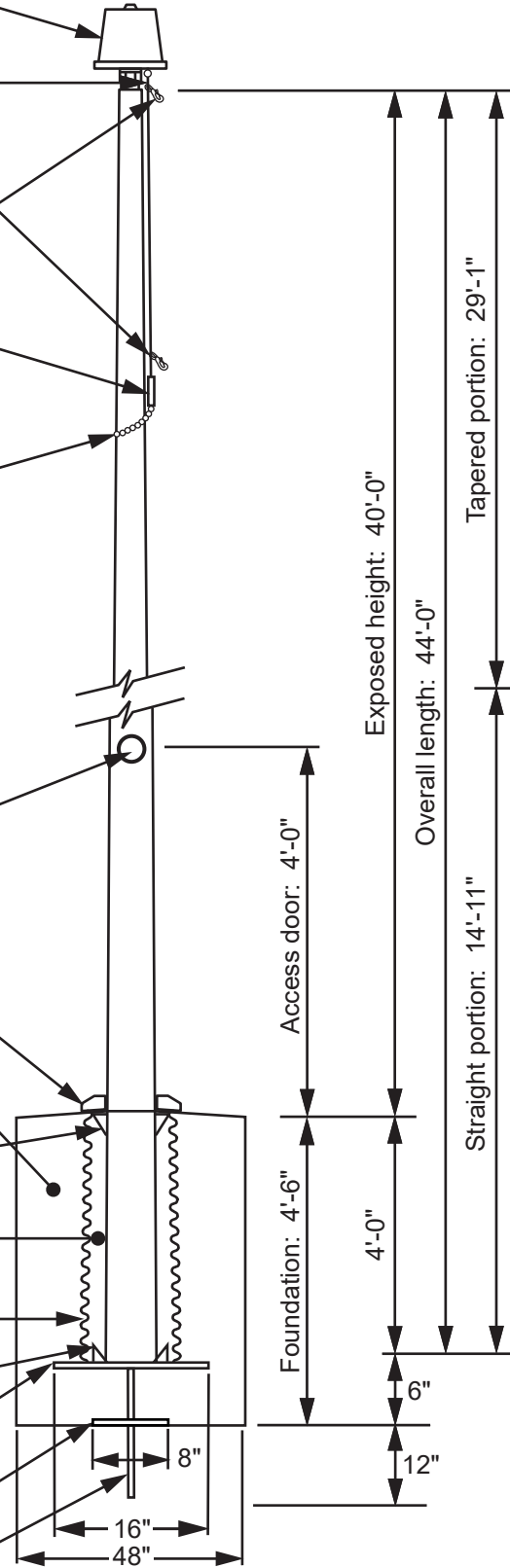

Revolving internal halyard truck,
cast aluminum body, enclosed
stainless steel ball bearings,
raceway and 2-1/2" diameter
plated steel sheave.

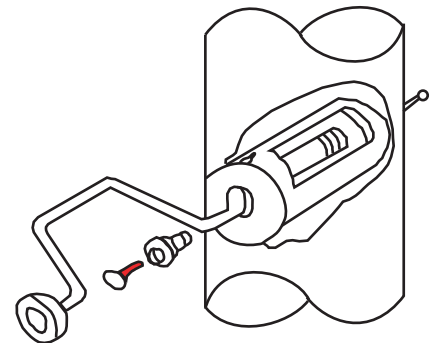

Winch Detail

All shafts with overall
length of more than
38'-6" are shipped in
two sections.

Each section matched and
marked for field assembly.
Exposed portion of jam
sleeve must be **well
lubricated** prior to
assembly.

1-1/2" maximum shop
gap allowed for field
fitting (ram for tight joint)

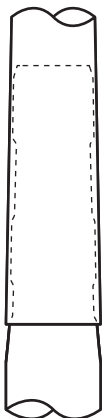

Project:	Date:
Location:	Job:
Contractor:	Revision:
Customer:	

Exposed Height	40'-0"
Overall Height	44'-0"
Butt Diameter	8"
Top Diameter	3-1/2"
Wall Thickness	.250"
Ships in 2 sections	

Ground set tapered aluminum flagpole ALLOY 6063T6 80 grit polish
FINISH:

EDER FLAG
1000 W. Rawson Avenue
Oak Creek, WI 53154
www.ederflag.com

